

MannTek

LPG



www.manntek.se

LPG Products by MannTek

As a market leader for LPG transfer products, MannTek provides well proven Dry Gas Couplings for safe connection and disconnection, Safety Breakaway Couplings to prevent pull-away accidents and Swivel Joints to avoid torsion of hose assemblies.

Our couplings are used worldwide to increase safety and eliminate the risks that come with handling hazardous media.





Content

DGC - Dry Gas Couplings	4 – 5
DGC Options	6 – 7
Pressure caps	8
SJ - Swivel Joints	9
SBC - Safety Breakaway Couplings - Breaking pin	10 – 11
SBC - Safety Breakaway Couplings - Cable release	12 – 13
MannTek Configurator	14
Application Pictures	15
Contact	16

MannTek Dry Gas Couplings are designed for a spill-free handling. They guarantee an economical, safe and environmentally friendly application within the LPG industry. We know the importance of eliminating unwanted leakage, product loss and a safe environment.

DGC

Dry Gas Couplings



Our long experience and the demanding requirements from the LPG industry has brought us into considerable product developments and technical solutions. We guarantee the highest level of safety and quickest way of connecting and disconnecting.

One single action, a straight forward push and a turning motion, connect the DGC for the loading and unloading of petroleum gas. A quick and easy “turn and pull” action close the valve and disconnect the couplings, with no spillage.

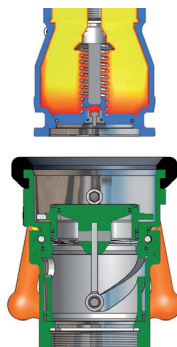

To connect

Push and turn
it's coupled

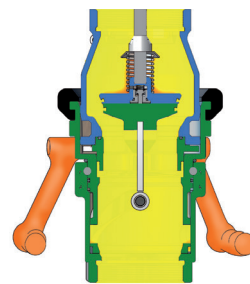

Full Flow

it's coupled
with full flow

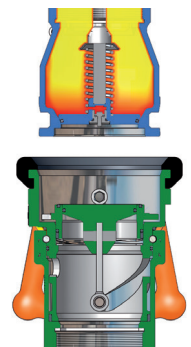

To disconnect

Turn and pull
it's released, no spillage



Approvals



Applications

- Top and bottom loading of tank trucks, bulk tanks, rail tankers etc.
- Coupling from tank truck to customer storage tank
- Sampling

Advantages

- Easy to handle
Push and turn - free flow.
Turn and pull - closed.
- Time saving
No need to drain hoses or pipe systems.
- Economical
No loss or spillage of liquids at connection or disconnection.
- Safe
The valve cannot be opened until the unit is coupled.
- Environmentally friendly
Accidental spillage eliminated.
- Quality
Designed for a long life cycle and an intense use over many years.

Technical information

Sizes:

1" (DN25) to 8" (DN200)

Materials:

Stainless steel.

Seals:

FKM LT. Others on request.

Maximum working pressure:

PN 16 / 25 (232 / 363 psi), depending on size.

Connections:

Female and male BSP/ NPT.
Flanged connections DIN and ANSI.
Others on request.

MannTek Couplings have a big variety of options to help customise couplings according to the operators needs. Those features can be an extra safety feature, a help for easy operation or simply make it easy to install a coupling in a already existing transfer system.

Options

Pressure Equalizing Valve for Tank Units

If liquid can get trapped in the tank unit during operation so that it can not escape, there is the risk that the tank unit is damaged during coupling.

The Pressure Equalizing Valve within the tank unit relieves the pressure into the hose unit.

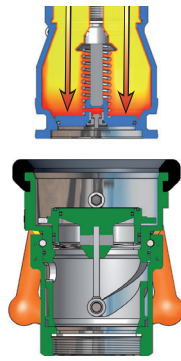

Trapped liquid in tank unit

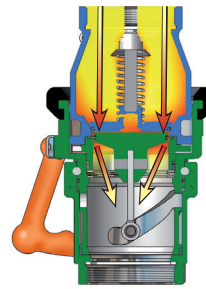

Open pressure equalizing valve, pressure expands into hose unit

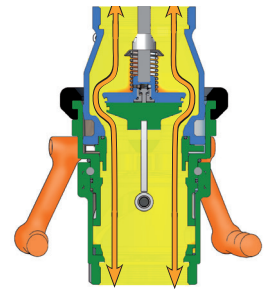

Continue to couple without pressure for a full flow



Stop Before Disconnect

This is a feature for detecting leakage in the tank unit.

After stop and control for leakage the user must manually unlock the hose unit before disconnection.

Both tank unit and hose unit shall be ordered in "Stop Before Disconnect" version.

Hose Unit with Integrated Breakaway

Where there is a risk of excessive force on the hose due to unexpected movement between the loading and unloading station, combining the DGC with a SBC.





Example 2" tank unit with excentric flange 4" ANSI 150

Tank Unit with Excentric Flange

Where there is a risk of liquid being left in the pipe, a tank unit with excentric flange minimises the remaining amount of liquid in the pipe after operation.

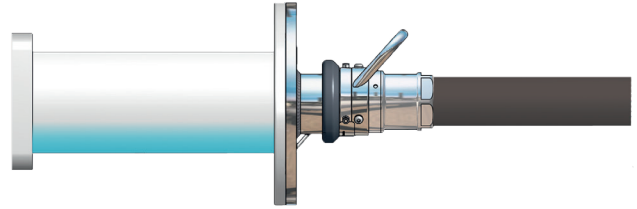

Traditional Flange

Liquid left in the tube

Tank unit with traditional flange

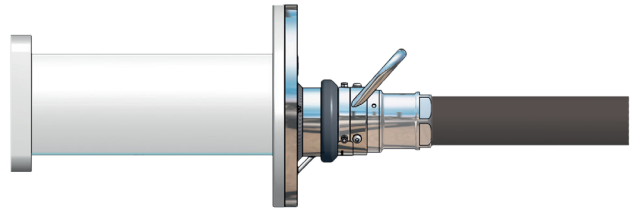

Excentric Flange

No liquid left in the tube

Tank unit with excentric flange

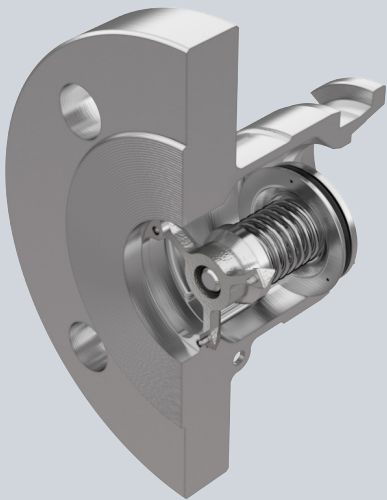

Tank Unit with Short Piston

When coupled, the piston spindle does not protrude.

This special type is useful e. g. for the direct connection to ball valves.

ACME and Whitworth Threads

DGC tank units and hose units are available with ACME and Whitworth threads for assembling direct on existing connections.

Open threaded ACME couplings have been used in the LPG industry for a long time resulting in high product losses, environmental effects and health risks.

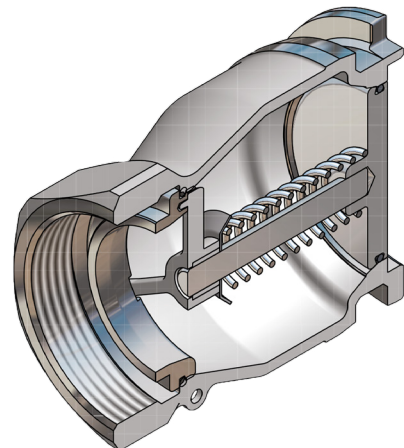

MannTek Pressure Caps, with built in pressure indicator, can be used as a second or third closure according to ADR/RID par 6.8.2.2.2. The pressure cap identifies a system pressure and keeps this pressure until the problem can be safely resolved. Designed to maximize the operator safety and a better environment.

Pressure Caps

with built in pressure indicator

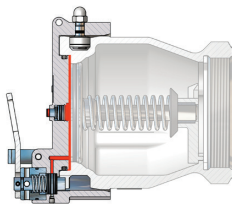
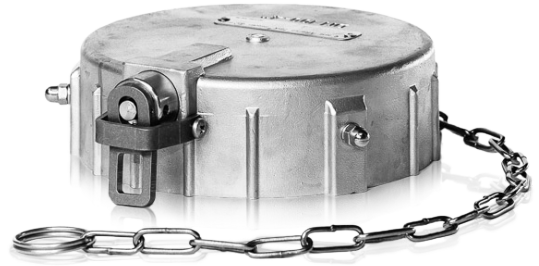

In case of an upstream leakage the cap will indicate it.

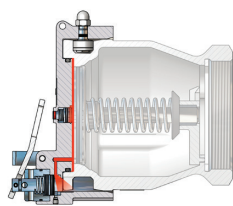

Press down the handle and any possible pressure is evacuated through a valve.

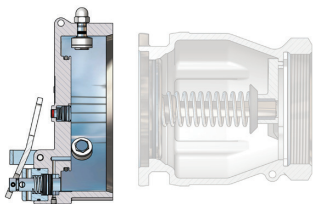

The cap can be removed safely.

Technical information

Sizes:
2" (DN50) to 4" (DN100)

Materials:
Stainless steel.

Seals:
FKM LT. Others on request.

Maximum working pressure:
PN 25 (363 psi)

Applications

- Used as a third closing device according to ADR/RID

Approvals



MannTek Swivel Joints helps avoiding torsion of hose assemblies, i.e. in filling machines, and improves the handling and coupling of nozzles for refuelling.

SJ

Swivel Joints

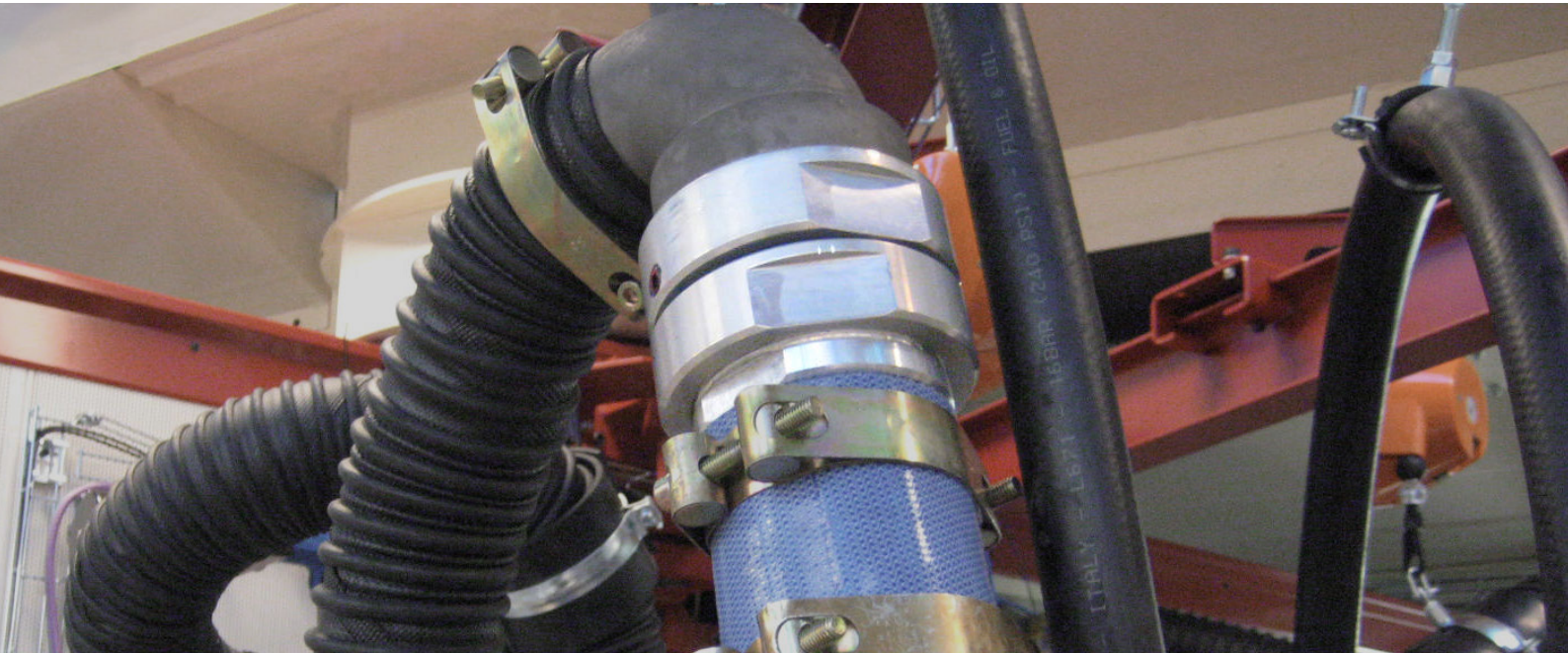

Technical information

Sizes:

1" (DN20) to 10" (DN250)

Materials:

Stainless steel. Others on request.

Seals:

FKM LT. Others on request.

Maximum working pressure:

PN 25 (363 psi)

Connections:

Female and male BSP / NPT, ACME
Flanged DIN and ANSI. Others on request.

Approvals



Applications

- Used in e.g. filling plants to avoid torsion.

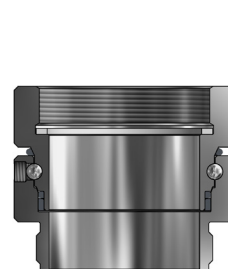

Single ball race

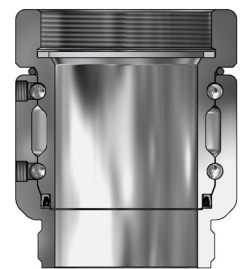

Double ball race

MannTek Safety Breakaway Couplings are available as Industrial and Marine type. Industrial Breakaways are used at fix points like manifolds, pipelines depots etc. They release by pull at any angle up to 90°. Marine Breakaways are installed between two hoses, they separate by axial pull only. The breaking force of the breaking pins can be customised to fit any application.

SBC

Safety Breakaway Couplings - Breaking Pin



Our Safety Breakaway Couplings are used to prevent pull away accidents. In case of e.g. a tank truck driving away with a hose or loading arm still attached, the two coupling halves will separate and immediately close the flow in both halves and directions and therefore prevent accidents and unwanted spillage of LPG.

SBC are the perfect choice to use in combination with DGC for a higher safety level of your transfer system.



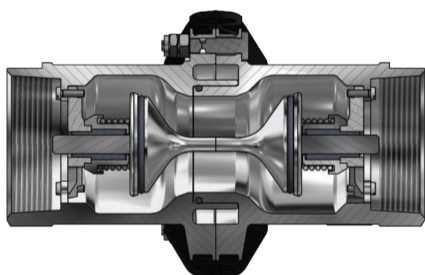
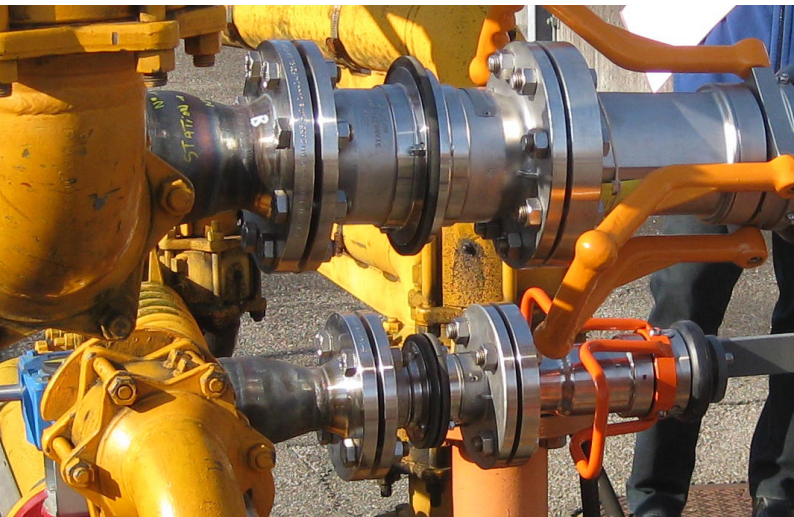

In Service

The coupling consists of two halves, each with a valve.

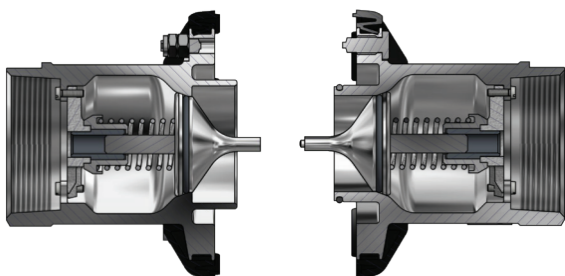

Released

After an emergency disconnection the coupling separates and both valves close immediately.

Applications

- Bulk loading / unloading, road tankers
- Rail tankers, process product transfer
- Ship to shore
- Loading arms

Advantages

- Easy to handle
Operates independently of shut off safety system and does not require an external power source.
- Time saving
Easy to reset on site with one person.
- Economical
Shut-off system of both coupling halves results in minimum product loss.
- Safe
Lightweight and robust design.
- Environmentally friendly
Accidental spillage eliminated.
- Reliability
Minimal loss or spillage of liquids when released.
- Quality
Designed for a long life cycle and an intense use over many years.

Technical information

Sizes:

1" (DN25) to 12" (DN300)

Materials:

Stainless steel. Others on request.

Seals:

FKM LT. Others on request.

Maximum working pressure:

PN 16 / 25 (232 / 363 psi), depending on size.

Connections:

Female and male BSP / NPT, flanged DIN and ANSI. Others on request.

Approvals



MannTek Safety Breakaway Coupling with cable release is a further development of our reliable breaking pin version which are successfully used worldwide in many different types of applications. The cable release coupling acts as a safety solution in the supply line of mobile transfer systems, preventing damage to the environment and facilities due to unexpected movement. The coupling halves separate regardless of internal pressure. The transfer system is not affected by external loads when releasing.

SBC

Safety Breakaway Couplings - Cable Release

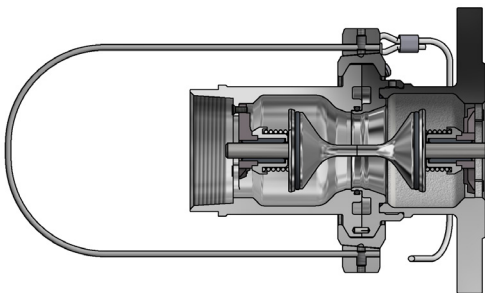

In Service

The coupling consists of two halves, each with a valve.

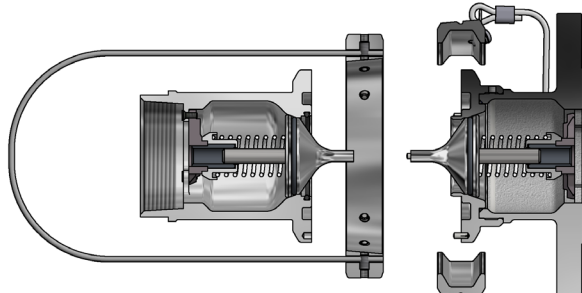

Released

After an emergency disconnection the coupling separates and both valves close immediately.



The coupling consists of two housing halves with a check valve in each. The housing halves are held together by two pressure clamps and a support ring during normal operation.

The two check valves support each other during normal operation and keep the conduit open.

Applications

- Loading arms
- Road tanker
- Rail tanker

Approvals



Advantages

- Easy to handle
Operates independently of shut off safety system and does not require an external power source.
- Time saving
Easy to reset, no spare parts needed.
- Economical
Shut-off system of both coupling halves results in minimum product loss.
- Safe
Lightweight and robust design.
- Environmentally friendly
Accidental spillage eliminated.
- Reliability
Minimal loss or spillage of liquids when released.
- Quality
Designed for a long life cycle and an intense use over many years.

Technical information

Sizes:

1" (DN25) to 6" (DN150)
Other on request.

Materials:

Stainless steel.

Seals:

FKM LT Others on request.

Maximum working pressure:

PN 16 / 25 (232 / 363 psi), depending on size.

Connections:

Female and male BSP / NPT, flanged DIN and ANSI. Others on request.

Release force:

100-1500 N, depending on size.

The **MannTek Configurator** is easy to understand and time saving when going through the range of MannTek products. Through just clicks it's possible to visualize the coupling, especially designed for your requirements and needs.

MannTek Configurator

<http://configurator.manntek.se>

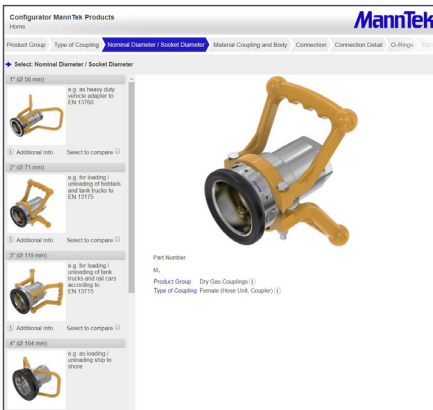

DGC

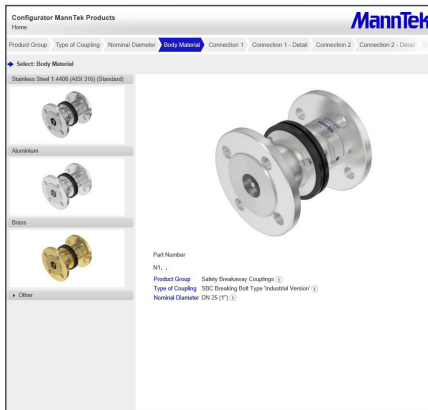

SBC

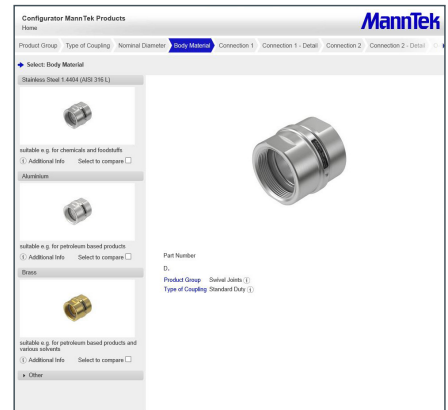

SJ



Advantages

- Easy to use
- Always up to date.
- Always available
- Choose out of the whole MannTek product range
- Save a PDF of your product for future enquires or send an enquiry directly to MannTek.

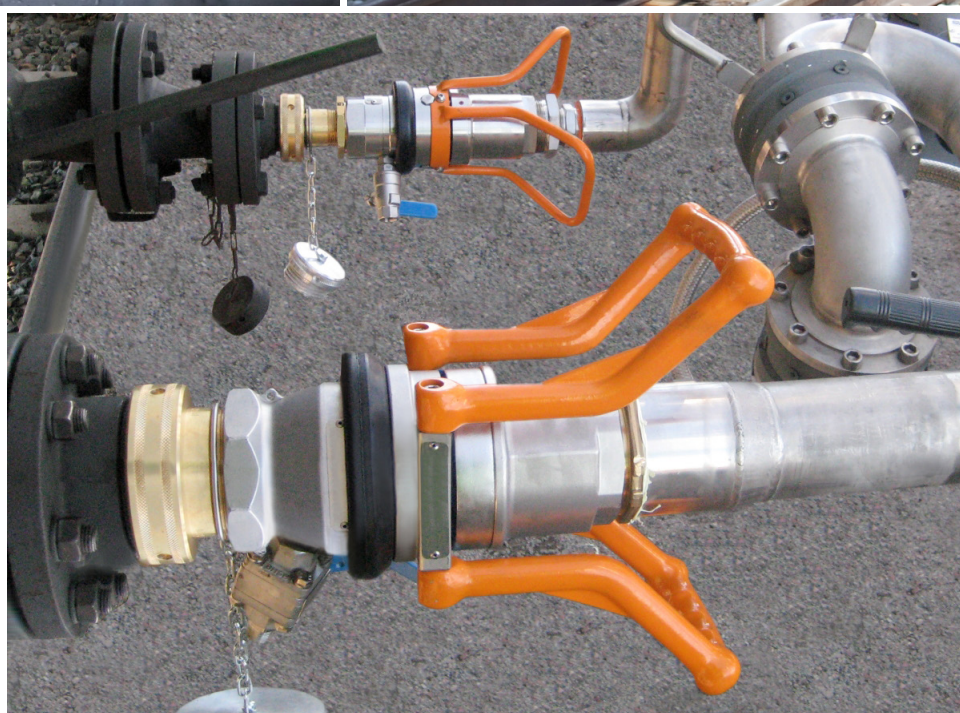
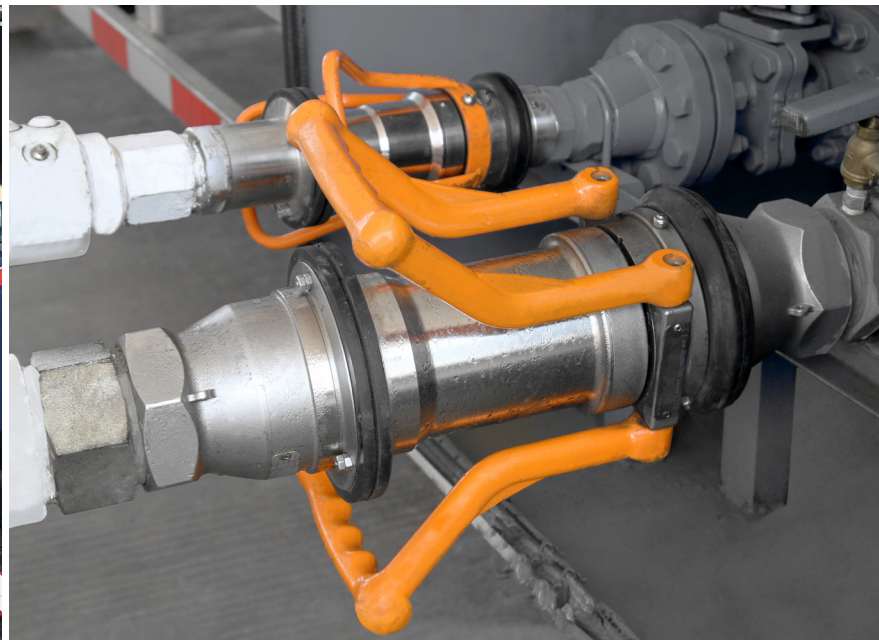
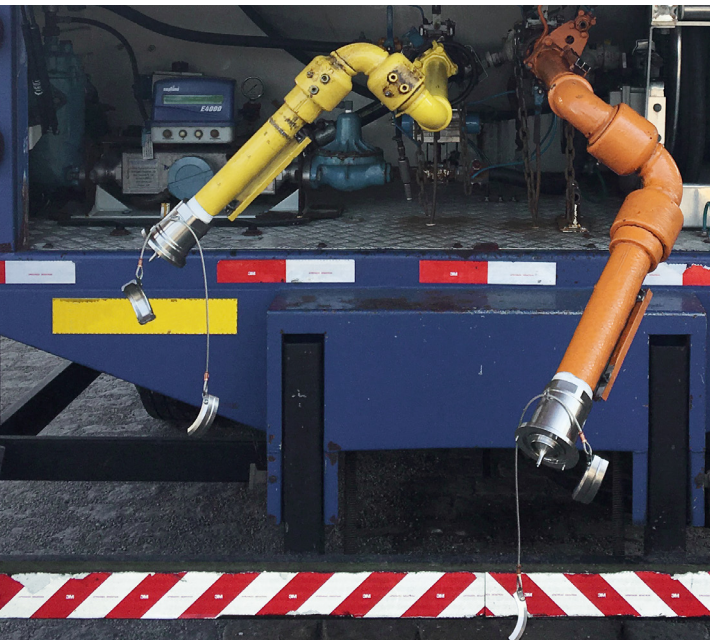



MannTek is the world market leader in spill-free coupling technology, with more than 20 years of experience from demanding applications. We design and manufacture specialised equipment for safe and environmentally friendly handling of aggressive fluids under harsh climatic conditions, servicing demanding clients all over the world. Our dedication to constant development and improvement makes our couplings the logical choice wherever quality and safety matter.

MannTek

Phone +46 501 39 32 00
Fax +46 501 39 32 09
Email sales@manntek.se
Website www.manntek.se
Address Mann Teknik AB
 Strandvägen 16
 S-542 31 Mariestad
 Sweden

Sales office

Argentina | Great Britain | Netherlands
 Sweden | United Arab Emirates

Company Approvals

